

Instructions for Use

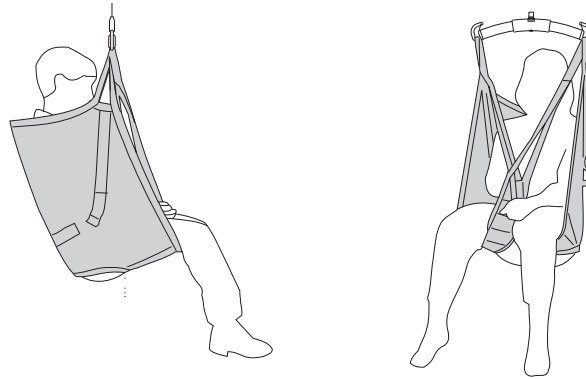

Product Description

Liko UniversalSling is a basic model which is designed to adapt to the patient without individual adjustments and is one of our most used slings.

The UniversalSling provides an upright sitting posture and supports the entire back up to the neck. If the patient needs support for the head it is recommended to use a high back sling, e.g. Original HighBack Sling Mod 200/210 or Soft Original HighBack Sling Mod 26. The patient's arms are held inside the sling. A properly fitted and carefully applied UniversalSling will give the patient an excellent sense of safety, as well as a high degree of comfort.

Sizes

The UniversalSling is available in different sizes. It is important to choose the correct size to achieve the highest level of comfort and safety. A sling which is too large increases the risk of the patient sliding out of it, while one which is too small can cut into the groin and cause discomfort.

For larger sizes, a combination with a twin bar 670 can be a good choice.

Fabrics

The UniversalSling is available in different fabrics. Since the UniversalSling is not usually left under the patient after the transfer, it is recommended to use the polyester design. This fabric is durable and has low friction making the sling easy to apply and easy to remove.

The UniversalSling is also available in net polyester. This fabric is recommended when the sling is left in place after the transfer or when an airier alternative is desired.

For bathing and showering, a plastic-coated net design is available, which is water permeable and can easily be wiped. This material dries quickly and does not chill the patient in the same way as a damp, absorbent fabric would.

The sling's lift straps are always made of durable polyester and are very secure.

Leg Supports

The UniversalSling is available with leg supports in several different designs. Most common are leg supports with reinforcements. The reinforcement provides high comfort, equalizes pressure and prevents the sling from creasing under the thighs.

Soft padded leg support (synthetic sheepskin) is available as an accessory. Universal sling with padded leg support is suitable for patients who are especially sensitive to pressure.

Suitable lifts

The UniversalSling can be used along with all of Liko's overhead and mobile lifts. You can choose between the overhead lifts LikoGuard™, Likorall™, and Multirall™ or the mobile lifts Golvo™, Viking™, Uno™, and Liko™ M220/M230.

In this document, the person being lifted is referred to as the patient and the person helping is referred to as the caregiver.



IMPORTANT!





















Lifting and transferring a patient always involves a certain level of risk. Read the instructions for use for both the patient lift and lifting accessories before use. It is important to completely understand the contents of the instructions for use. The equipment should only be used by trained personnel. Ensure that the lifting accessories are suitable for the lift used. Exercise care and caution during use. As a caregiver, you are always responsible for the patient's safety. You must be aware of the patient's ability to make it through the lifting situation. If something is unclear, contact the manufacturer or supplier.

Table of Contents

Symbol Description	3
Safety Instructions	4
Care and Maintenance	5
Definitions	5
How to Attach a Sling to Different Sling Bars	6
How to attach a UniversalSling to a sling bar with 4 hooks (twin bars and cross bars)	7
Lifting from a Sitting Position	8
Lifting to a Sitting Position	9
Removing the Sling in a Chair/Wheel chair	10
Lifting from the Bed.....	10
Lifting to the Bed.....	11
Removing the Sling when Sitting in Bed	11
Removing the Sling when Lying in Bed.....	11
Fitting Advice.....	12
Different Ways of Connecting Leg Supports.....	12
The Patient does not Sit Well in the Sling – Why is This?	12
Shortening Position	13
Accessories.....	13
Overview Liko UniversalSling, Mod. 000,	14
Recommended Combinations	14

Symbol description

These symbols can be found in this document and/or on the product.

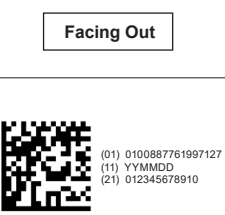
Symbol	Description
	Warning. Used were extra care and attention is needed.
	Read instructions for use before use
	Read instructions for use before use
	CE mark
	Legal manufacturer
	Date of manufacturing
	Ref number
	Serial Number
	Medical device
	Do not dry clean
	Do not iron
	Tumble drying
	Do not tumble dry
	Washing Symbol is always in combination with recommended temperature in °C and °F.
	Latex Free
	Periodic inspection
	No not bleach
	Line drying in shade
	Direction upwards and symbol on outside of equipment.
	Symbol on outside of equipment.
	GS1 Data Matrix Barcode that may contain following information. (01) Global Trade Item Number (11) Production Date (21) Serial Number

Safety Instructions

⚠ Before lifting, keep the following points in mind:

- A responsible person within your organization should decide on a case-by-case basis whether one or more caregivers are needed.
- Ensure that the sling selected meets the patient's needs with reference to model, size, fabric and design.
- The total maximum load for a lift system is always determined by the product in the system with the lowest specified maximum load.
- For safety and hygiene reasons, use individual slings.
- Plan the lifting operation so that it can be done as safely and smoothly as possible.
- Check that the lifting accessory hangs vertically and can move freely.
- Although the Liko sling bars are equipped with latches, special caution must be exercised. Before the patient is lifted from the underlying surface, but when the straps are fully extended, make sure the straps are correctly connected to the sling bar hooks.
- Make sure the patient is sitting securely in the sling before transferring to another location.
- Never lift a patient higher off the underlying surface than is needed to complete the lifting and transfer procedure.
- Never leave a patient unattended during a lifting situation.
- Make sure that the wheels on the wheelchair, bed, gurney, etc., are locked during the lifting/transfer operation.
- Always work ergonomically. Use the patient's ability to actively participate in the operations.
- When the sling is not being used, do not place in direct sun light.

⚠ **Incorrect attachment of sling to slingbar may cause severe injury to the patient.**

⚠ **Manually turning the patient in bed may cause injuries to the caregiver.**

CE Medical Device Class I Product

PATENT www.hillrom.com/patents

May be covered by one or more patents. See above Internet address.

The Hill-Rom companies are the proprietors of European, US, and other patents and pending patent applications.

Product Changes

Liko's products undergo continuous development, which is why we reserve the right to make product changes without prior notice. Contact your Hill-Rom representative for advice and information about product upgrades.

Design and Quality by Liko in Sweden

Liko is quality certified according to ISO 9001 and its equivalence for the medical device industry, ISO 13485.

Liko is also certified according to environmental standard ISO 14001.

Notice to Users and/or Patients in EU

Any serious incident that has occurred in relation to the device, should be reported to the manufacturer and the competent authority of the Member State in which the user and/or patient is established.

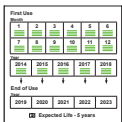

Before First Use

Before the sling is used the first time, the date (year and month) should be marked on the label "First Use" (placed under the label "Perform Inspection"), please see the example below. The marking is made by cutting the green threads in the relevant squares. The threads are cut with one cut in the middle of the square. Do not cut off the threads completely - let the cut thread ends remain.

Example: February 2014

First Use	
Month	Year
1	2014
2	2015
3	2016
4	2017
5	2018
6	
7	
8	
9	
10	
11	
12	
End of Use	
Year	
2019	2020
2021	2022
2023	

Expected Life - 5 years

Cut the threads in the middle of the square.



Care and Maintenance

Check the sling before each use. Check the following points with regard to wear and damage:

- Fabric
- Straps
- Seams
- Suspension loops

⚠ Do not use damaged lifting accessories.

If anything is unclear, please contact the manufacturer or supplier.

If the sling is used for bath or shower: After use in bath and shower situations, the sling should be placed so that it dries as soon as possible.

Washing Instructions: Please see the sling's product label and the attached appendix "Care and Maintenance of Liko Slings".

Periodic Inspection

The product must be inspected at least once every 6 months. More frequent inspections might be required if the products are used or washed more often than normal. See Liko's protocol "Periodic Inspection Liko Textile Products". For protocols please contact your Hill-Rom representative.

Expected Life Time

If the product is made of green woven polyester fabric, the product has an expected life time of 5 years. If the product is made of plastic coated net or grey net polyester, the product has an expected life time of 3 years. The expected life time is based on 10 uses per day and washing once per week, according to washing instructions. Hill-Rom recommends the product be used only during its expected life time.

Recycling Instructions

The entire product, including laths, padding material, etc. should be sorted as Combustible waste.

Hill-Rom evaluates and provides guidance to its users on the safe handling and disposal of its devices to aid in the prevention of injury, including, but not limited to: cuts, punctures of the skin, abrasions, and any required cleaning and disinfection of the medical device after use and prior to its disposal. Customers should adhere to all federal, state, regional, and/or local laws and regulations as it pertains to the safe disposal of medical devices and accessories.

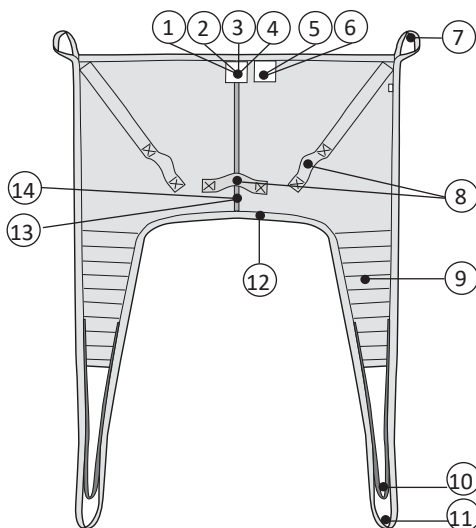

If in doubt, the user of the device shall first contact Hill-Rom Technical Support for guidance on safe disposal protocols.

Definitions

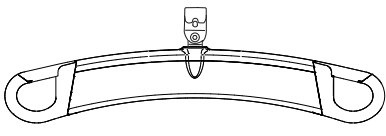
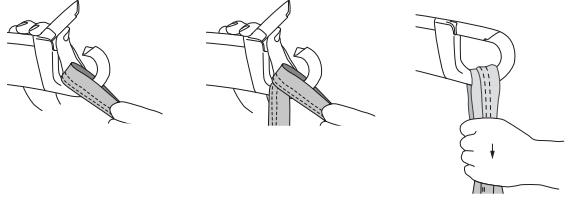
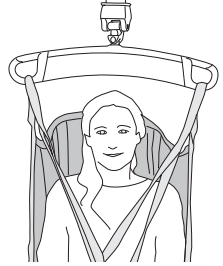
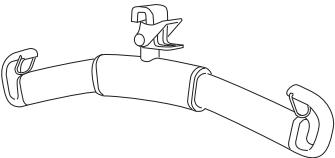
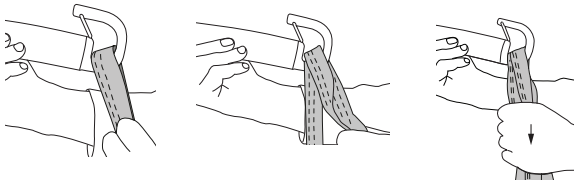

1. Product label
2. Label: Manufacturing year and month ()
3. Label: Serial number
4. Label: Individual marking (Belongs to)
5. Label: Check and inspect (Perform Inspection)
6. Label: The first time the product is used (First Use)
7. Upper strap loop
8. Handle
9. Leg support
10. Shortening position
11. Outer leg support loop
12. Lower edge
13. Centre back strap
14. Size marking

How to attach a sling to different sling bars

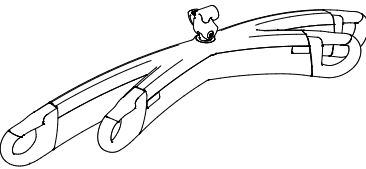
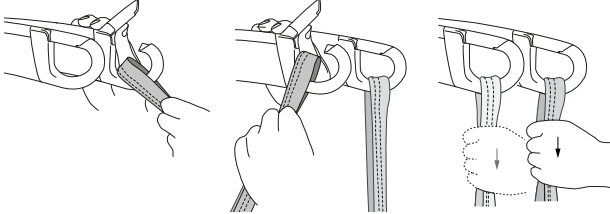
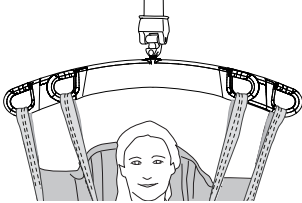
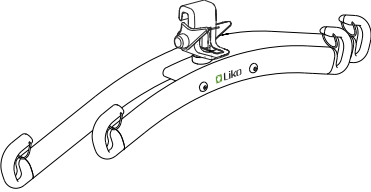
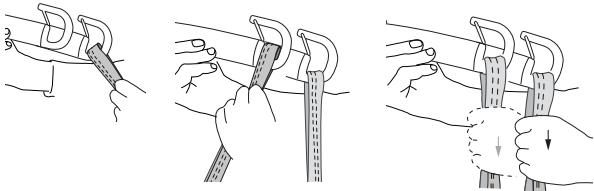
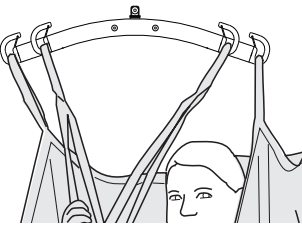
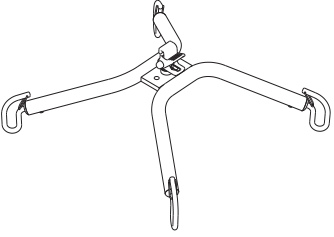
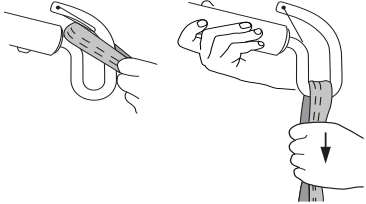
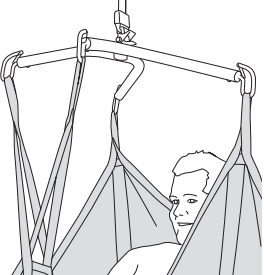
Sling bar	Sling loops to sling bar hooks	Correct
 <p>SlingGuard™</p>		
 <p>Universal</p>		
 <p>SlingGuard™ Twin</p>		
 <p>Universal Twin</p>		
 <p>Cross-bar</p>		

Example: Misuse

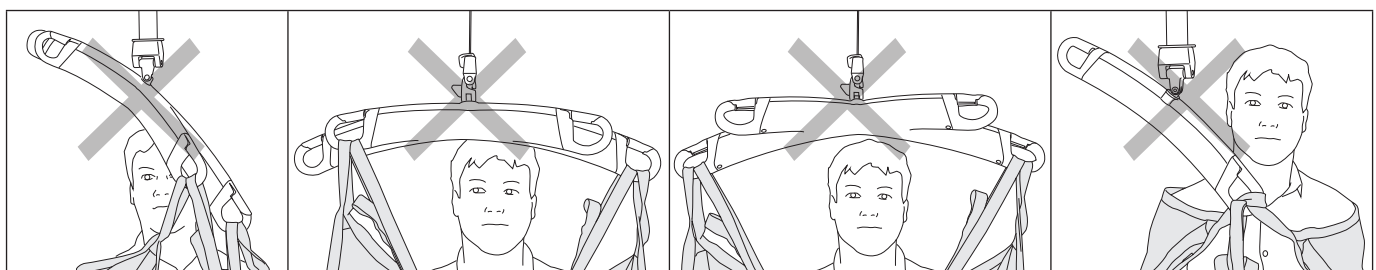

How to attach a UniversalSling to a sling bar with 4 hooks (twin bars and cross bars)

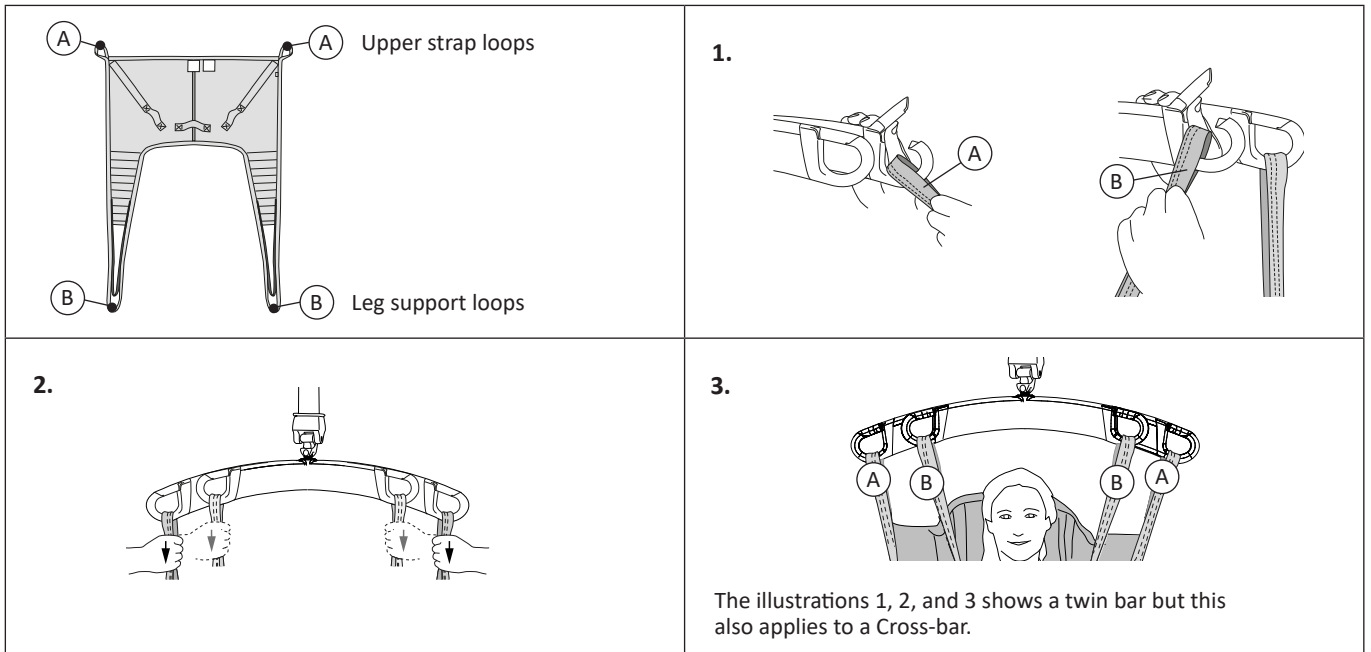

Lifting from the Sitting Position

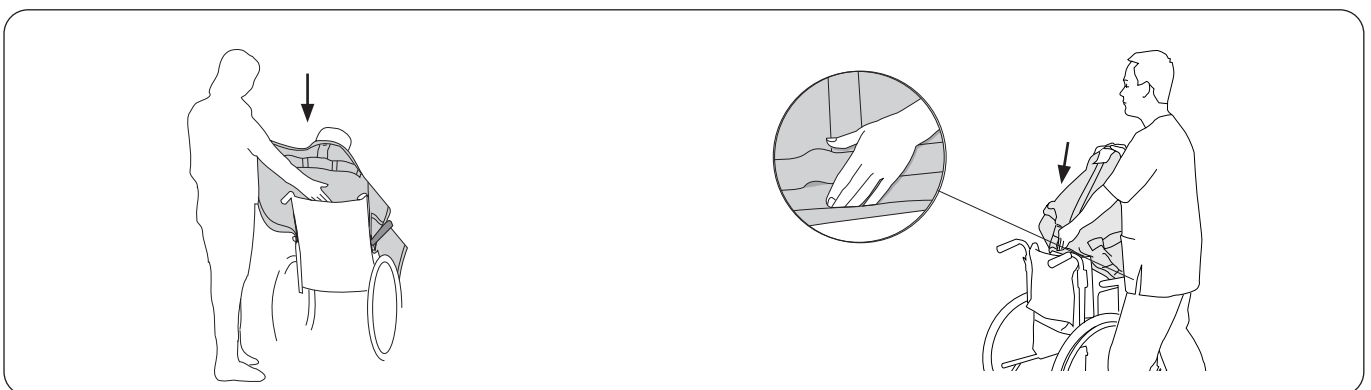

Place the sling behind the patient's back with the product label outwards. Fold up the lower edge of the sling around your finger tips to facilitate guiding the sling into place.

Using the palm of your hand, push the lower edge of the sling down to the level of the patient's coccyx -this is very important. Note: Correct positioning is facilitated if the patient leans/is leaned forward slightly.

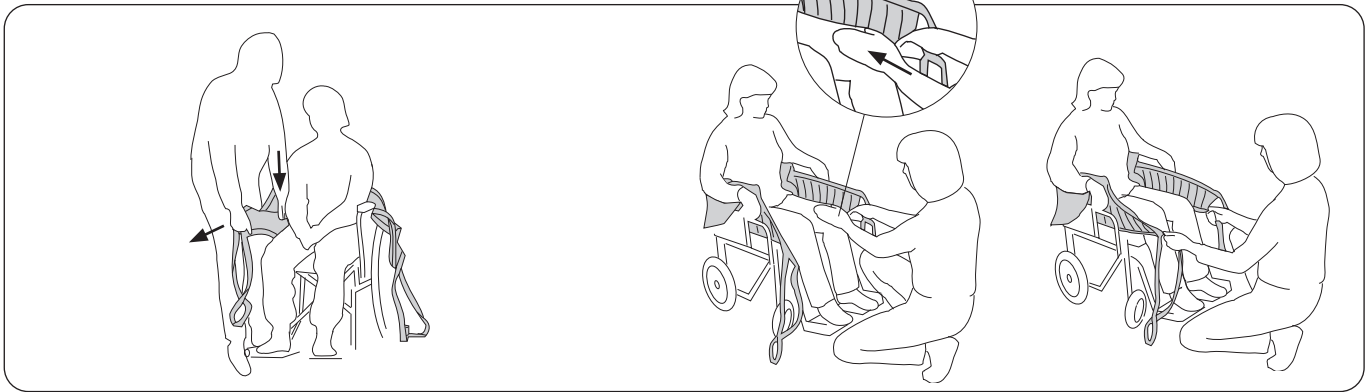

Pull the sling's leg supports forward along the outside of the patient's thighs. Place the palm of your hand between the patient's body and the sling and push the leg support's lower edge down towards the seat. Simultaneously, pull the leg support forward with the other hand to stretch it.

Pull the leg supports forward to smooth out any creases in the back. Check that both leg supports protrude the same distance. Note: A gentle hold under the knee-cap makes it easier to pull the leg supports forward.

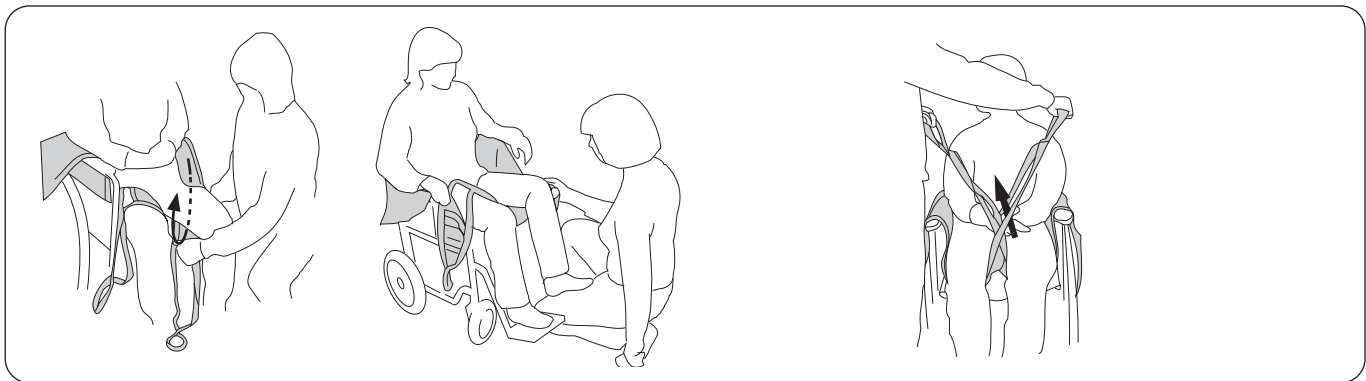

Insert the leg supports under each thigh. Make sure the fabric lies flat and that it reaches properly around the leg. **Note:** The application of the leg supports is facilitated if the patient's legs are slightly raised from the seat. This can be achieved by placing the patient's feet on the foot-rests or on your own leg, as illustrated.

Prepare the connection of the leg supports. The most common way of applying the sling is with crossed leg supports. For alternative methods, see page 12.

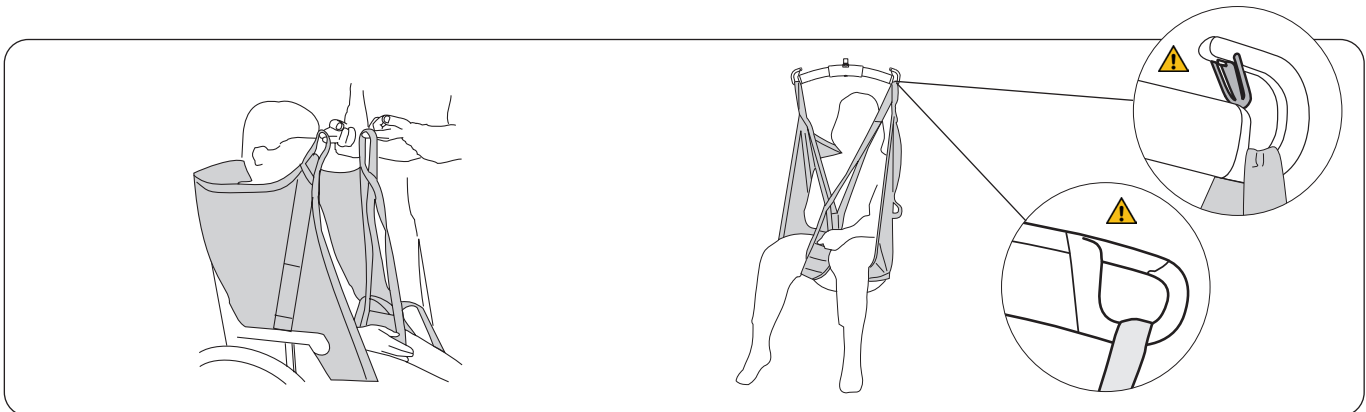

Note: Check that all suspension loops have the same length, i.e., are at an equal height when they are stretched prior to lifting. Adjust the position of the sling if they are not at an equal height.

First connect the upper strap loops to the sling bar hooks, then the leg support loops. See page 6-7 for instructions on how to attach the sling loops to different sling bars. Lift the patient.

Lifting to the Sitting Position

When placing a patient in a wheelchair, it is important that the patient gets far enough back in the chair to sit well. This can be accomplished in several ways.

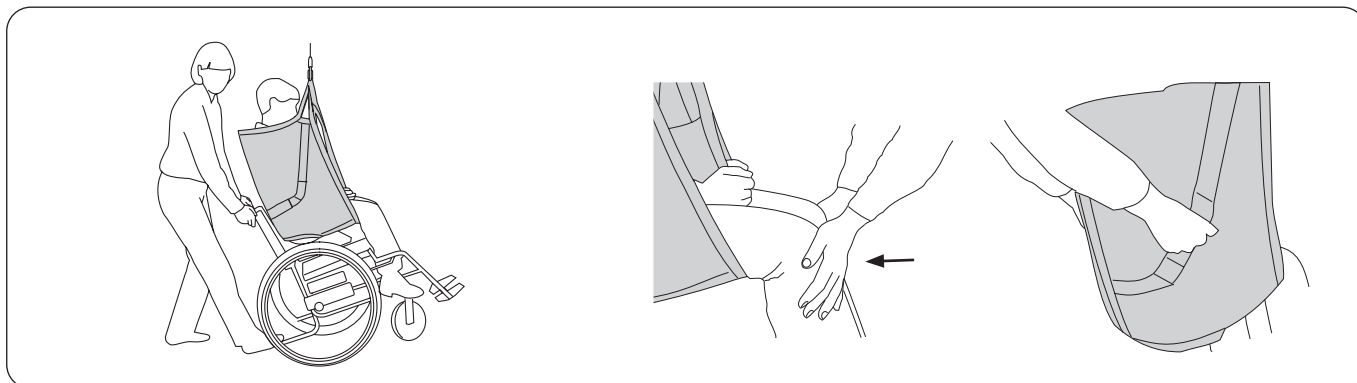

When placing a patient in a wheelchair: Lean the chair backwards during the lowering of the patient. Let the buttocks slide down the backrest during the last part. Control the angle of the wheelchair with your foot on the tipping support.

Alternative: Apply slight pressure under the patient's knees during the lowering sequence, so that the buttocks are guided towards the backrest of the chair. If the sling has handles, these can be used to guide.

⚠ Do not use the handles to lift! Excessive force on the handles can cause the sling to tear.

Removing the Sling in a Chair/Wheelchair

It is recommended to remove the sling after the transfer. If for some reason it is preferable to leave the sling in the chair after transfer, it is recommended to use a sling in net polyester.



Carefully remove the leg supports. The gentlest way of doing this is by pulling out the leg support loops under the fabric part.

Remove the sling by carefully pulling the leg support up.

Lifting from the Bed

The sling can be applied in different ways depending of the status of the patient. Either it is applied with the patient lying in bed or sitting in bed. If an advanced pressure-relieving mattress is used, it can to advantage be inflated maximally to facilitate the application of the sling.

Remember your own work posture and the patient's comfort. Use the bed's functions for raising and lowering. Good work posture is obtained when the mattress is level with the caregiver's knuckles when the arms are held completely down. Depending on the burden on the caregiver, an evaluation of how many caregivers are needed for the operation must be made on a case to case basis.

Applying the Sling when Lying in Bed

For lifting from a supine position without the possibility of raising the head end of the bed or otherwise supporting the head, it is recommended to use Liko Soft Original HighBack Sling Mod. 26, or alternatively Liko Original HighBack Sling Mod. 200, 210, which all provide support for the head.

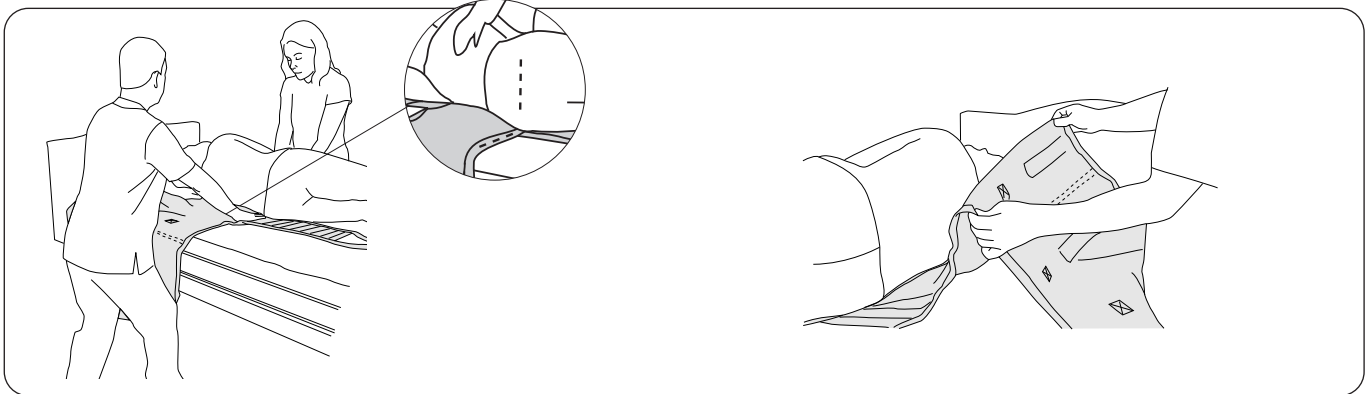

Turn the patient to the side. This operation is facilitated if the patient himself can contribute by gripping the bed rail on the side to which he is to be turned. Place the edge of the sling towards the back of the patient with the lower edge **level with the coccyx**.

Fold the sling so that its "centre back strap" corresponds to the patient's spine. Check that the fold covers the sling's edge which is in towards the back of the patient in order to reduce the friction. Turn back the patient gently and pull out the sling on the other side. With this application technique, the patient needs to be turned once only.

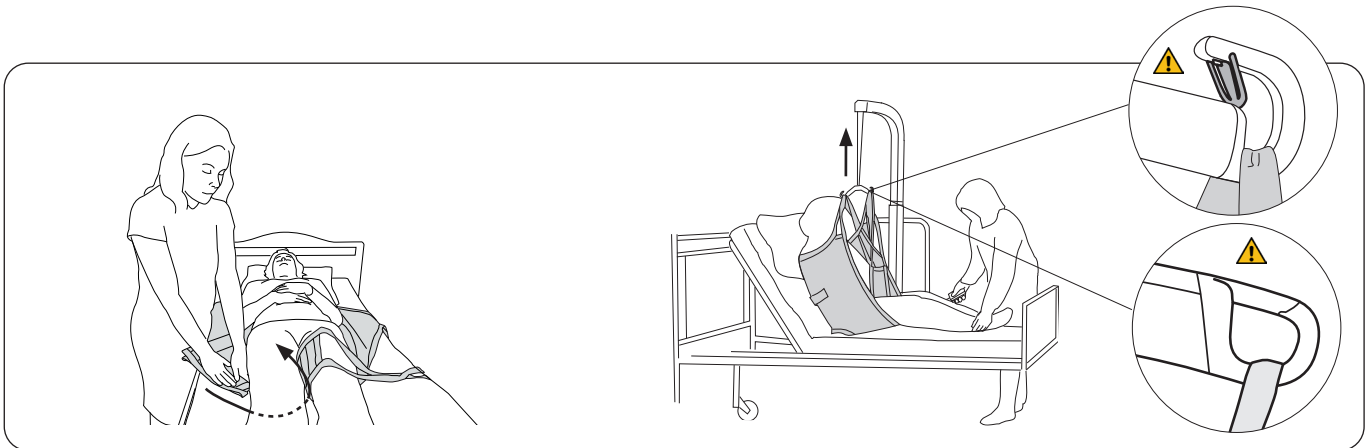

Insert the leg supports under each leg. This is best done by pressing the leg support down against the mattress while inserting it under the knee. Make sure the fabric lies flat and that it reaches properly around the leg. The leg supports can be connected in different ways, see page 12.

Raise the head end of the bed. First connect the upper strap loops to the hooks of the sling bar, then the leg support loops. See page 6-7 for instructions on how to attach the sling loops to different sling bars. Lift the patient.

Applying the Sling when Sitting in Bed

Raise the head end of the bed behind the patient. Lay the sling on the bed with the product label facing down towards the mattress. Slide the sling down behind the patient's back so that the lower edge **is level with the coccyx**. **Note!** The application is facilitated if the patient leans/is leaned forward.

Lifting to the Bed

It is recommended to remove the sling after the transfer. If for some reason it is preferable to leave the sling in the bed, it is recommended to use a sling made of net polyester.

Remember your own work posture and the patient's comfort. Use the bed's functions for raising and lowering. Good work posture is obtained when the mattress is level with the caregiver's knuckles when the arms are held completely down. Depending on the burden on the caregiver, an evaluation of how many caregivers are needed for the operation must be made on a case to case basis.

Removing the Sling when Sitting in Bed

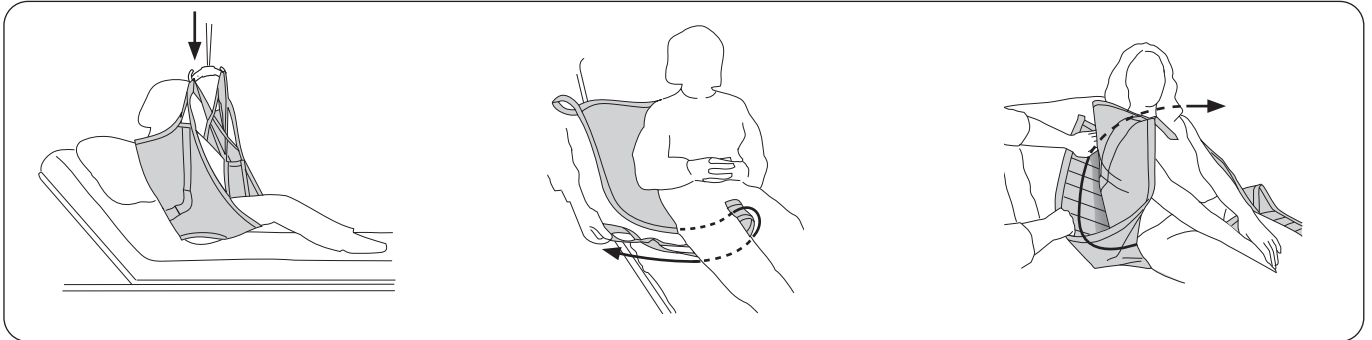

Position the patient above the bed. Raise the head end of the bed for the patient's comfort. Lower the patient onto the bed.

Remove the leg supports by pulling out the leg support loops under the fabric part. **Note:** This is facilitated if the patient's legs are bent.

Remove the sling by pulling one of the leg supports behind the sling and over to the opposite side.

Removing the Sling when Lying in Bed

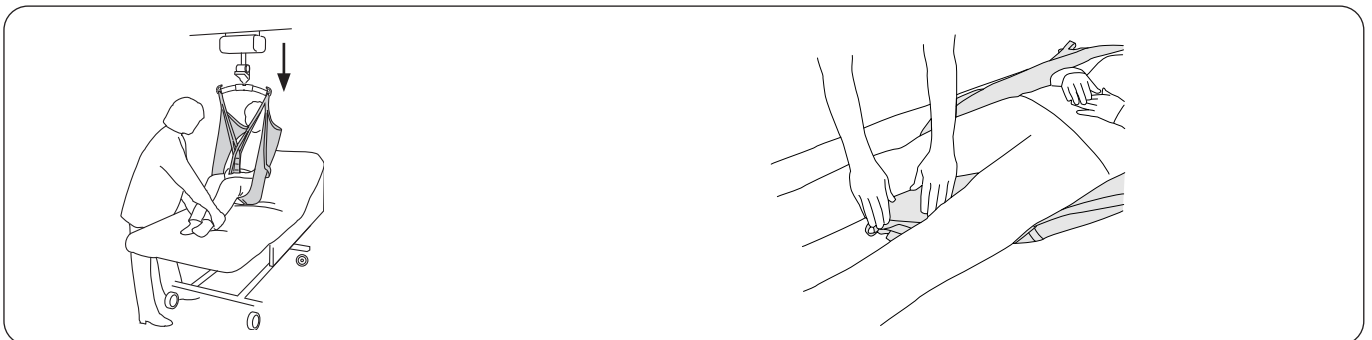

Position the patient above the bed. Raise the head end of the bed for the patient's comfort. Lower the patient onto the bed. Lower the head end.

Place the leg support loops under the leg supports between the patient's legs.

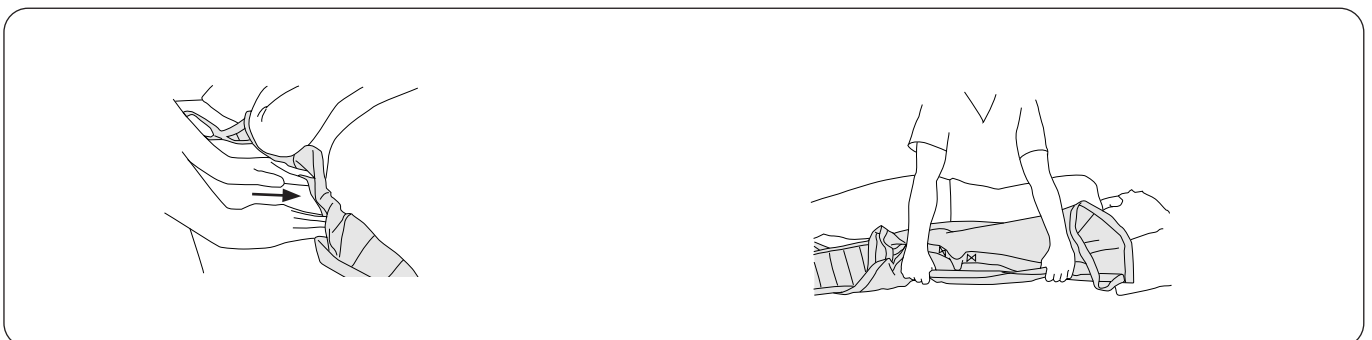

Grasp the edge of the sling. Push in the sling under itself. Press the sling against the mattress and in under the patient.

Carefully turn the patient onto the side. Grasp the sling from below and remove it carefully.

Fitting Advice

Different Ways of Connecting Leg Supports

Before a connection alternative is chosen, an individual assessment should be performed to anticipate possible risks.

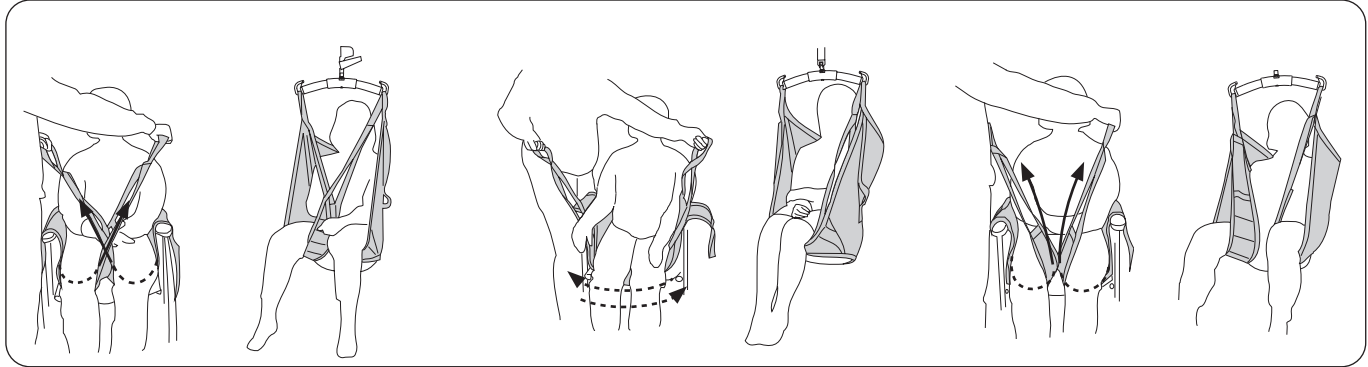

Crossed-over leg supports.

The most common way of applying the sling. One leg support loop is passed through the other before the loops are connected to the sling bar.

Overlapped under both thighs.

This can be appropriate, for example when lifting a patient with amputated legs. **Note:** In order to avoid the patient's sitting posture being too reclined, Extension Loops can be attached to the leg support loops.

Each leg support connected separately to the sling bar.

This can be appropriate when lifting patients with particularly sensitive genitals.

⚠ Increased risk of sliding out.

The Patient does not Sit Well in the Sling – Why is this?

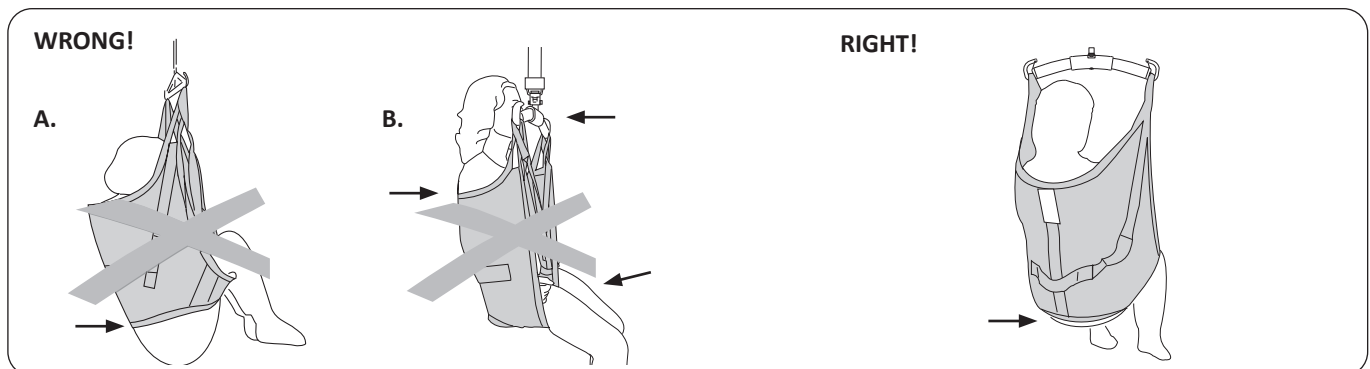

A. Risk of sliding out. The buttocks hang down. The sling may be too large. It can also be due to the fact that the sling has not been pulled down the patient's back sufficiently.

Before lifting, check that the lower edge is stretched and that the fabric reaches properly around the legs.

B. Too small sling can cause the leg supports to cut into the crotch causing discomfort, the sling bar to be too close to the face and/or the back to get insufficient support.

The lower edge of the sling is at the same level as the coccyx. The leg supports are properly positioned under the legs.

Shortening Position

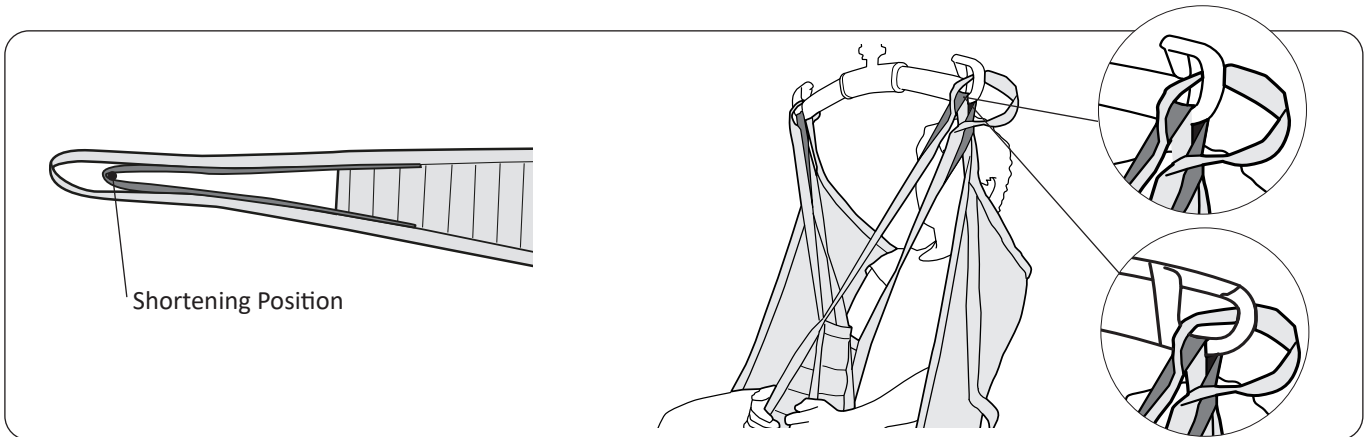

Our sling is carefully designed to ensure that the patient always sits with pressure well distributed between legs and back section for good support during transfers. However, in certain cases it can be preferable to use the inner setting, the "shortening position", on the leg support loop to change the patient's sitting position.

Note: This does **not** apply if you have an older model of the UniversalSling, Mod. 00/02, with an earlier design of the shortening position. For a description of the shortening procedure for Mod. 00/02, please contact Hill-Rom to obtain the instructions for use for that model.

In cases where the shortening position is used, it is recommended that you also connect the outer leg support loop to the sling bar hook in order to have better visual control of the loops.

Accessories

Extension Loop, green, 12 cm (5 in)
Extension Loop, green 22 cm (9 in)
Extension Loop, grey, 12 cm (5 in)
Extension Loop, grey, 22 cm (9 in)

Prod. No. 3691102
Prod. No. 3691103
Prod. No. 3691302
Prod. No. 3691303

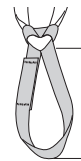

- 2 = 12 cm (5 in)
- 3 = 22 cm (9 in)

Overview Liko UniversalSling, Mod. 000

Product	Prod. No.	Size	Patient's Weight ¹	Max. Load ²
Liko UniversalSling	35000--4	S	35-55 kg (77-121 lbs)	200 kg (440 lbs)
Liko UniversalSling	35000--1	M-Slim (slim adult)	45-70 kg (99-154 lbs)	200 kg (440 lbs)
Liko UniversalSling	35000--5	M	60-90 kg (132-198 lbs)	200 kg (440 lbs)
Liko UniversalSling	35000--6	L	80-120 kg (176-264 lbs)	200 kg (440 lbs)
Liko UniversalSling	35000--7	XL	>110 kg (>242 lbs)	300 kg (660 lbs)

¹ The indicated patient weight is a guideline only – there may be deviations.

² To maintain maximum load, lift/accessories intended for the same load or more are required.

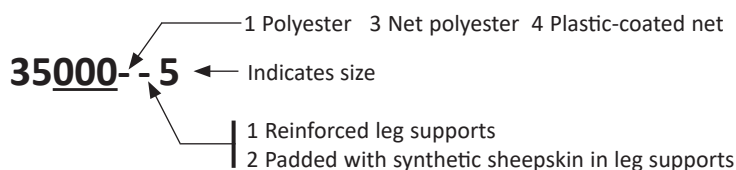

Recommended combinations:

Recommended combinations of the Liko™ UniversalSling and Liko's sling bars:	Mini 220	Sling bar 350 ³	Sling bar 450 ¹	Sling bar 600 ⁴	Twin bars 670 ²	Sling Cross-bar 450	Sling Cross-bar 670	Univ. Side bars + Universal 350	Univ. Side bars + Universal 450
UniversalSling, S	3	2	1	3	2	1	2	2	2
UniversalSling, M-Slim	3	2	1	3	1	1	1	1	1
UniversalSling, M	3	2	1	3	1	1	1	1	1
UniversalSling, L	3	2	1	1	1	1	1	1	1
UniversalSling, XL	3	3	2	1	1	1	1	1	1

¹ Sling bar 450 relates to Universal SlingBar 450 Prod. No. 3156075, 3156085, and 3156095, SlingBar Standard 450 Prod. No. 3156001, 3156003, 3156007, and 3156016, and also SlingGuard 450 Prod. No. 3308020 and 3308520.

² Twin bars 670 relates to Universal TwinBar 670 Prod. No. 3156077, and 3156087, and also SlingGuard 670 Twin Prod. No. 3308040 and 3308540.

³ Sling bar 350 relates to Universal SlingBar 350 Prod. No. 3156074, 3156084, and 3156094.

⁴ Sling bar 600 relates to Universal SlingBar 600 Prod. No. 3156076 and 3156086.

Explanation: 1 = Recommended, 2 = May work, 3 = Not advised, 4 = Inappropriate

Other Combinations

Combinations of accessories/products other than those recommended by Liko can result in risks for the safety of the patient.



www.hillrom.com

Liko AB
Nedre vägen 100
975 92 Luleå, Sweden
+46 (0)920 474700

Liko AB is a subsidiary of Hill-Rom Holdings, Inc.

Enhancing outcomes for patients and their caregivers:

